





















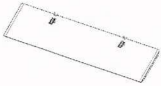







ASSEMBLY INSTRUCTIONS JK400

TOOLS REQUIRED: One knife to open packaging | Two ½ “ wrench or socket (metric 13) | One 9/16” wrench or socket (metric 14) | One #2 Philips (+) screwdriver | One 7/32” allen wrench (metric 6)

Note: all bolts are 9/16” (metric 14) and nuts are ½” (metric 14)

We highly recommend 2 people work together to assemble. Also, we suggest placing on soft surface when laying out and assembling: ie cardboard or a blanket.

Please watch the video at joracomposters.com under the assembly tab.

Parts JK400		Joraform AB 2013-04-09			
	Ha (1X)		Ea (1x) Metal		K (2x) Plastic
	Hb (3x)		Eb (1x) Metal		Aa (2x)
	Hc (2x)		Fa (2x) Insulation		N (4x)
	Hd (1x)		Fb (1x) Insulation		O (10x)
	Q (2x)		B (2x)		L (2x)
	R (2x)		C (2x)		M (2x)
	G (1x)		D (1x)		X (28x)
	P (6x)		J (4 large) J (6 med)		Y (12x)
	T (12x) Plastic		U (20x) Plastic		Z (12x)
	V (20x) Plastic				



ASSEMBLY INSTRUCTIONS JK400

1

For all connections hand tighten only for step 1.

Hand tighten one nut #J to one end of each of the threaded at the end steel rods #B

Place cross brace #R on the ground

Set one piece of the stand #Aa "V" shaped on top of the brace (Note: the stand has a front and back, back has 2 extra holes for cross brace)

Fasten one end of the flat bar #R to the front inside hole of the side frame with the bolt #P and nut #J. The bolt goes through the cross brace #R and secures the 3 pieces together.

Insert one rod #B through bottom back hole and cross brace #R

Insert the other rod #3 through top middle hole.

2

Slide hollow metal rods #C over each of the threaded rods previously completed

3

Slide long black tube #D over top steel pipe.

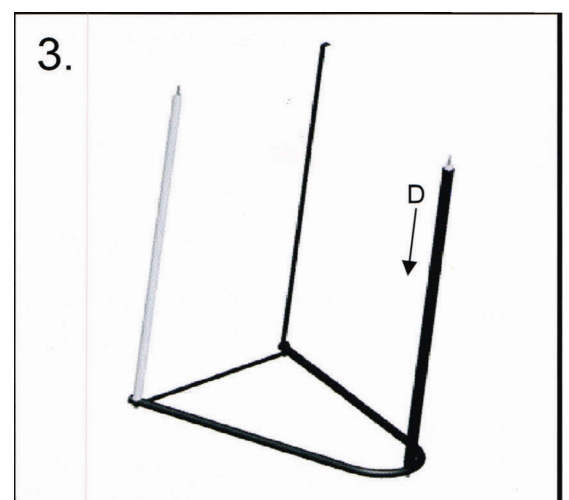
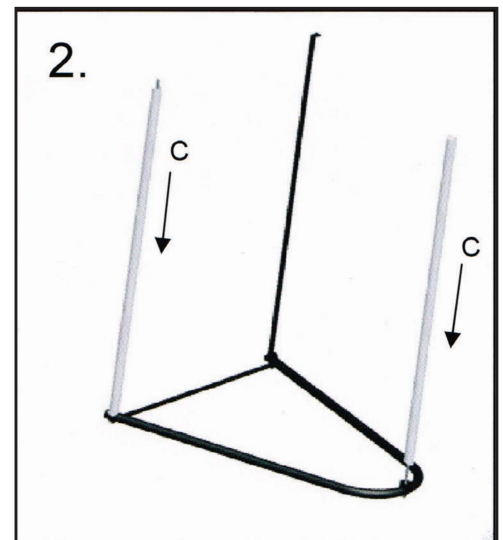
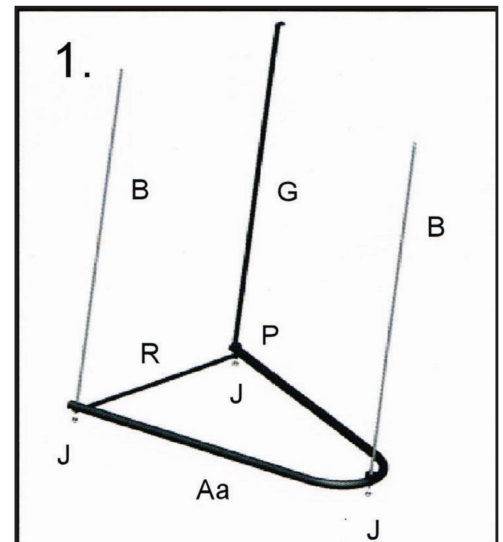



ASSEMBLY INSTRUCTIONS JK400

4

Note: Octagon metal side #Ea is the one that does not have extra holes for the handles. #Eb has 12 additional holes for the 4 handles.

Slide shortest black tube #M over long black tube.

Slide octagon metal side #Ea (painted side down) over the long black tube until it reaches the small black tube on the bottom.

Slide on medium length black tube #L until it reaches metal side.

Slide the Octagonal foam insulation piece #Fa (one of two with ventilation holes) over the long and medium black tube until it reaches the metal side piece. Line up ventilation holes.

Slide the octagon plastic piece #K over the black tube until it rests on the medium tube #L near the center of the tumbler.

Slide on the octagonal insulator #Fb (the one that does not have ventilation holes)

Slide on 2nd octagon plastic piece #K to rest on insulation and sandwich the insulation.

Slide on 2nd medium plastic pipe #L

Slide on octagonal insulation piece #9 over the medium pipe.

Attach the handles to the second metal octagon #Eb, as noted above this metal octagon panel has 12 extra holes for attaching the handles.

We recommend attaching the handles before installing Eb to the tumbler as follows.

3 of the handles are attached with one steel brace #O on the inside of the panel and one on the outside sandwiching the panel, then the handle is on top using the short Allan bolts #Y and nuts #Z to secure them.

The 4th handle uses 3 of the braces #O on the outside and one on the inside, this is to allow clearance for the tumbler door to open without hitting the handle, the 3 long Allan bolts #Y and nuts #Z are used to fasten.

Slide on 2nd metal side #Eb with the handles and line up ventilation holes.

Add the 2nd small black tube #M.

Note: The diagram shows you can now insert the nylon bolts, nuts and washers. I find it easier to install these after Sketch 4 when the unit is standing up and after one panel has been installed. It is up to you which you choose.

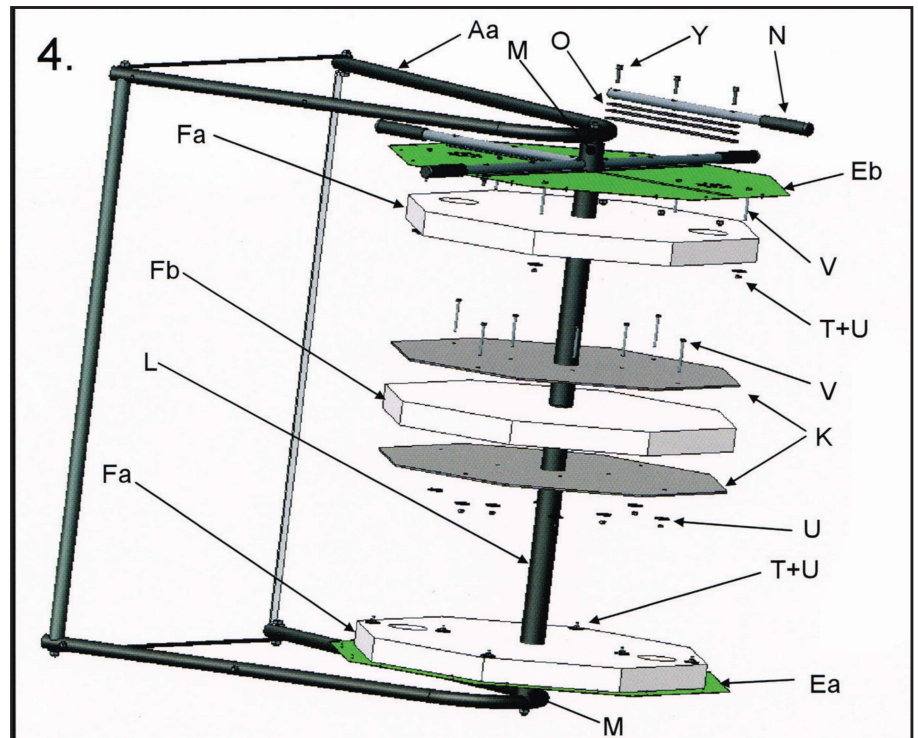



ASSEMBLY INSTRUCTIONS JK400

4

Continued

Place 2nd side of the stand #Aa on the 2 metal threaded rods, and front brace #G, attach locknuts on the top and bottom rods after adding the 2nd side cross brace #R. Be sure the cross brace is on the threaded rod and attached by the locknut.

Place and attach X brace #Q with bolts #P and locknuts #J to rear of stand.

Have 2 people stand up the composter.

Tighten all nuts and bolts.

Note: the ends of the hollow metal tubes are formed at each end to conform to the sides to prevent spinning and strengthens the composter. When tightening the locknuts you may need the second person to lift the center slightly as well as securing the nut to position this properly.

Line up the Octagonal insulation panels with the ventilation holes and sides and insert plastic screws #V, through the insulation, add washer #T and bolt #U. (hand tighten) There are no pre-drilled holes in the insulation, applying pressure to the nut will force it through. Washers are only used on the end panels.

Repeat at other end.

For the middle section line up the sides and push the screws through #T and attach nut #U. (no washers are used for these).

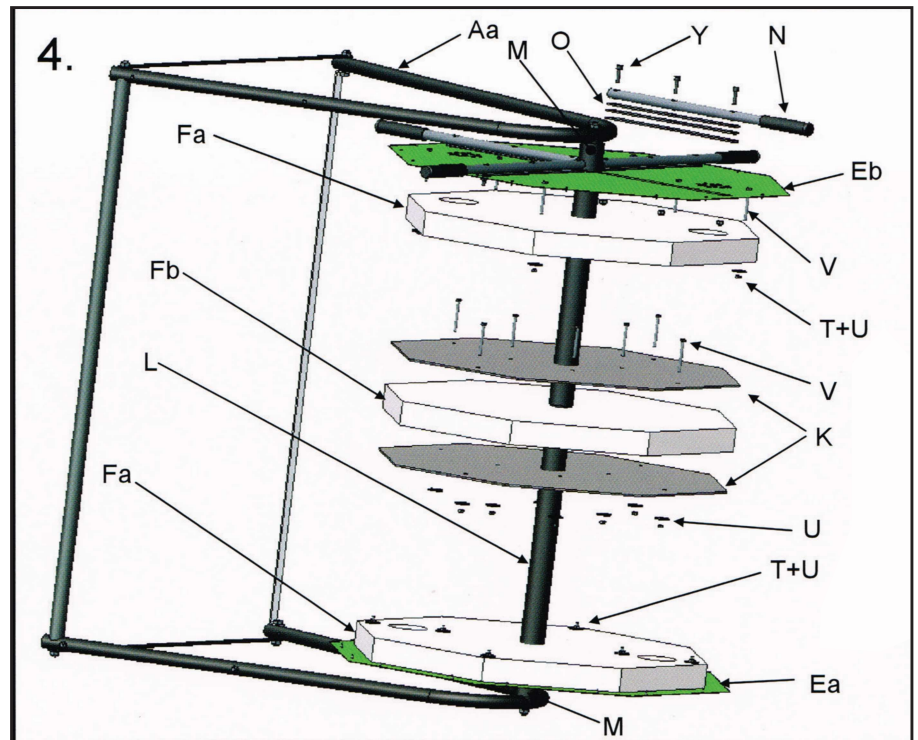



ASSEMBLY INSTRUCTIONS JK400

Panel Placement

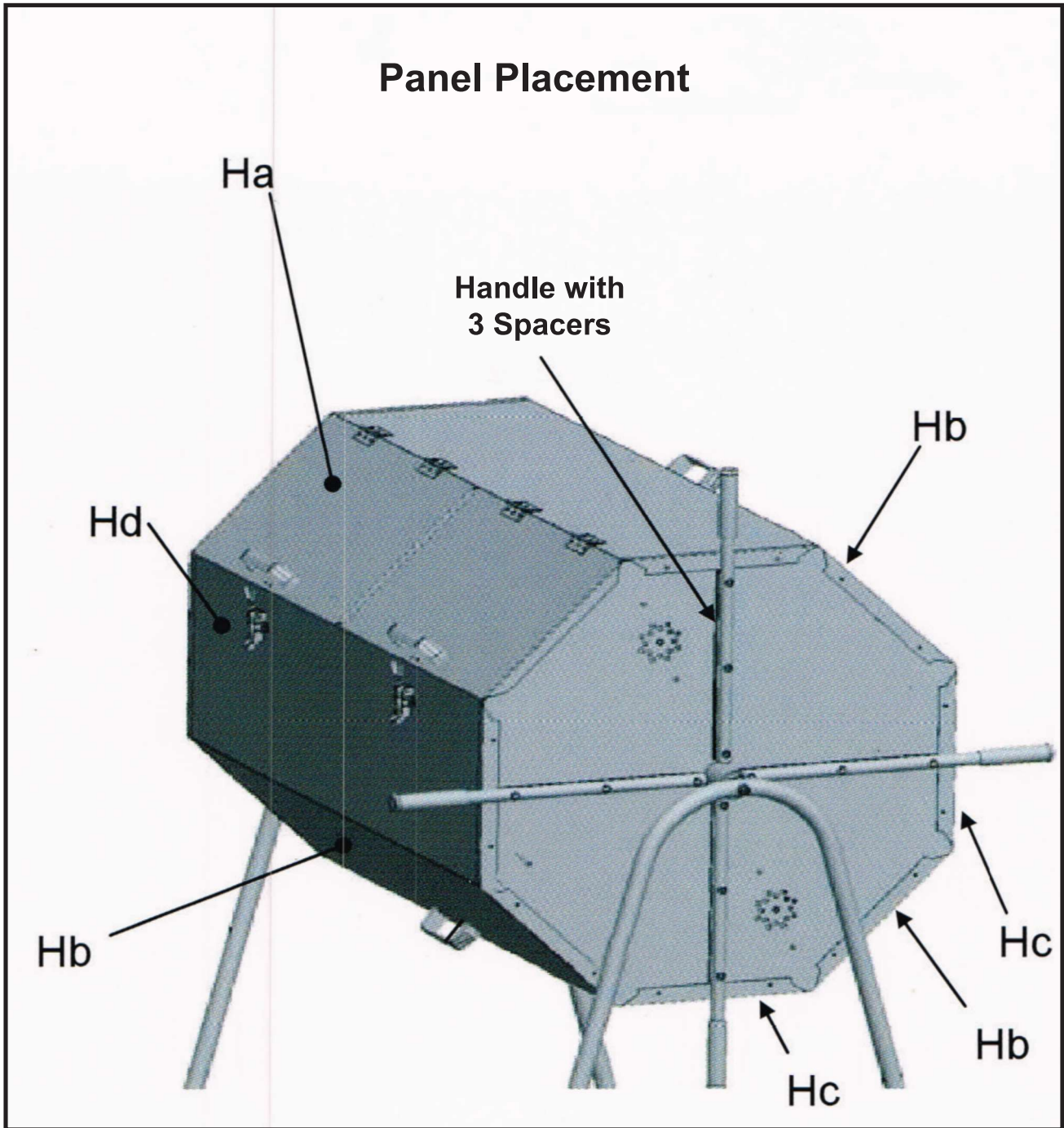



ASSEMBLY INSTRUCTIONS JK400

5

It is very important to have 2 people to add the side panels to prevent the composter from spinning.

Line up the octagonal panels. With the handle with the extra spacers for the door at the top.

The first panel to add is the one with the doors attached #Ha. The fixed panel goes on the top where the handle is, the doors are below on the front side as shown in the diagram 5.

Line up the predrilled holes and insert the 4 screws # to attach panel and doors. Applies to all the panels

Next add panel #Hd with the door latches below the doors (be cautious of the doors opening as they are not attached until this panel goes on)

Line up the predrilled holes and insert the 4 screws # to attach panel and doors.

Add the next panel with a handle #Hb the same way lining up the screw holes.

Adjust to locks screwing the latch in or out so it closes comfortably and locks the 2 doors.

Note: You can now add the Plastic bolts, nuts, washers shown in Diagram 6, I find it easier than having to reach in the doors for these.

Add the next panel with a handle #Hb the same way lining up the screw holes.

Alternate flat panels #Hc and handles Hb until complete.

Note: Laying the tumbler back on the blanket for the above after attaching the first couple of panels may make it easier to apply pressure to line up the holes.

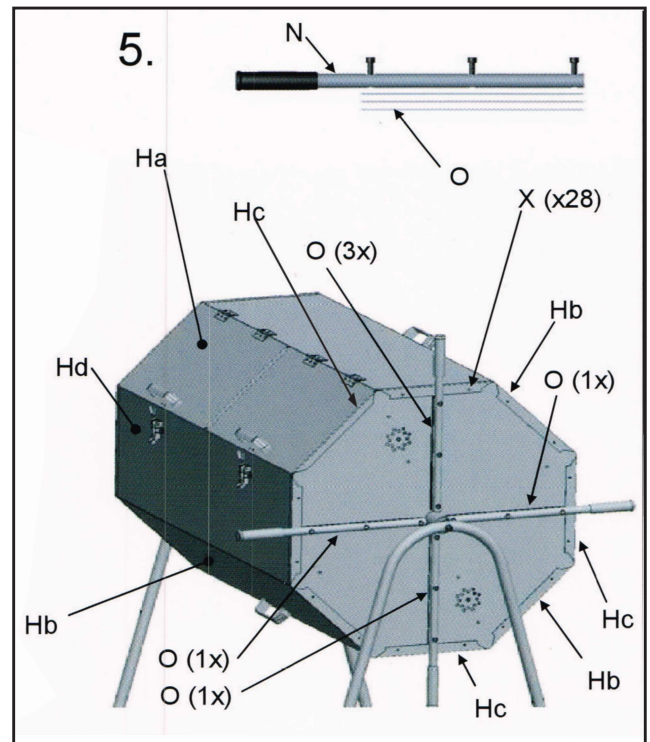



ASSEMBLY INSTRUCTIONS JK400

6-8

Complete any missing plastic bolts and washers.

Stand it up, check all screws, nuts, and bolts. When all are secure you are ready to compost.

